



Air preparation units

- modular configuration
- compact design
- simple mounting
- relieving

The service equipment for compressed air is configured as required for each of the following individual devices:

- Filter drain
- Diaphragm pressure regulator
- Micro lubricator
- Pressure gauge
- Shut off valve
- Soft Start valve
- Stop valve
- Fine filter
- Activated carbon filter

Technical Data	
Body material	PlasticGrivory GV-6H with 60 % glass fiber
Process connection Size 0-1/8", 1, 2, 4 Size 0-1/4"	Zinc die-cast PlasticGrivory GV-6H with 60 % glass fiber
Medium	Compressed air, neutral gases
Media temperature	0 to +50°C at 10 bar (Ü)
Ambient temperature	0 to +50°C
max. supply pressure Size 0 Size 1, 2, 4	12 bar (ü) 16 bar (ü)
Control range	0,5–10 bar
Size 0	Connection 1/8" and 1/4"
Size 1	Connection 1/4" and 3/8"
Size 2	Connection 3/8" and 1/2"
Size 4	Connection 3/4" and 1"
ATEX Zone 2, Category 3G, EX-Group IIA, IIB and IIC Zone 22, Category 3D Zone 1, Category 2G, EX-Group IIA, IIB and IIC Zone 21, Category 2D Temperature class T4	All equipment with size 1 and 2 except electrically operated valves
Standard filter sizes Filter regulator 2 piece service unit 3 piece service unit Filter Fine filter Activated carbon filter	5 µm 5 µm 5 µm 5 µm 0,01 µm, remaining oil content < 0,01 mg/m ³ Remaining oil content < 0,005 mg/m ³

Other versions on request.

Ordering chart, 3-piece service unit, fully assembled

Semi-automatic filter drain, diaphragm pressure regulator and micro lubricator, without pressure gauge and mounting parts.

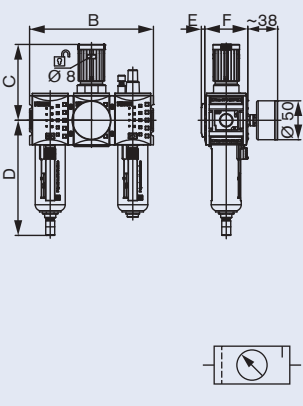

Built size	Port size	B [mm]	C [mm]	D [mm]	E [mm]	F [mm]	Qmax. at P=6,3 bar and Δp=1bar, l/min.	Item no.	
								G-threaded connection	NPT-threaded connection
0	1/8"	129.0	63.0	105.0	6.0	48.0	500	771 903	n/a
0	1/4"	129.0	63.0	105.0	6.0	48.0	500	771 904	n/a
1	1/4"	156.0	95.5	129.5	4.0	54.0	1700	771 905	772 761
1	3/8"	156.0	95.5	129.5	4.0	54.0	1700	771 906	772 762
2	3/8"	189.0	110.0	147.0	6.0	67.0	3500	771 907	772 763
2	1/2"	189.0	110.0	147.0	6.0	67.0	3500	771 908	772 764
4	3/4"	255.0	137.0	192.0	5.0	93.0	12000	771 909	772 765
4	1"	255.0	137.0	192.0	5.0	93.0	12000	771 910	772 766

Ordering chart, 2-piece service unit, fully assembled

Semi-automatic filter regulator and micro lubricator, without pressure gauge and mounting parts

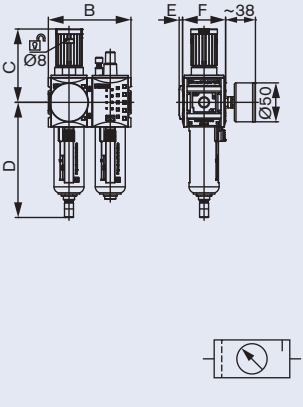

Built size	Port size	B [mm]	C [mm]	D [mm]	E [mm]	F [mm]	Qmax. at P=6,3 bar and Δp=1bar, l/min.	Item no.	
								G-threaded connection	NPT-threaded connection
0	G 1/8"	86.0	63.0	105.0	6.0	48.0	500	771 911	n/a
0	G 1/4"	86.0	63.0	105.0	6.0	48.0	500	771 912	na
1	G 1/4"	104.0	95.5	129.5	4.0	54.0	1700	771 913	772 753
1	G 3/8"	104.0	95.5	129.5	4.0	54.0	1700	771 914	772 802
2	G 3/8"	126.0	110.0	147.0	6.0	67.0	3500	771 915	772 757
2	G 1/2"	126.0	110.0	147.0	6.0	67.0	3500	771 916	772 758
4	G 3/4"	170.0	137.0	192.0	5.0	93.0	12000	771 917	772 759
4	G 1"	170.0	137.0	192.0	5.0	93.0	12000	771 918	772 760

Ordering chart, Filter regulator

without pressure gauge and mounting parts

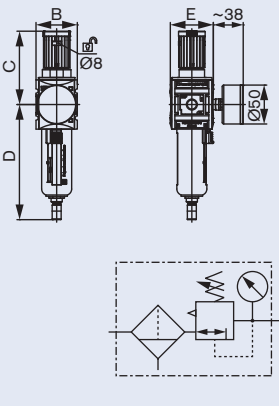

Built size	Port size	B [mm]	C [mm]	D [mm]	E [mm]	Qmax. at P=6,3 bar and Δp=1bar, l/min.	Item no.			
							G-threaded connection with half auto. condensate drain	G-threaded connection with auto. condensate drain	NPT-threaded connection with half auto. condensate drain	NPT-threaded connection with auto. condensate drain
0	G 1/8"	43.0	63.0	105.0	48.0	1000	771 919	772 193	n/a	n/a
0	G 1/4"	43.0	63.0	105.0	48.0	1000	771 920	772 194	n/a	n/a
1	G 1/4"	52.0	95.5	129.5	54.0	2200	771 921	772 195	772 723	772 729
1	G 3/8"	52.0	95.5	129.5	54.0	2600	771 922	772 196	772 724	772 730
2	G 3/8"	63.0	110.0	147.0	67.0	4300	771 923	772 197	772 725	772 731
2	G 1/2"	63.0	110.0	147.0	67.0	5200	771 924	772 110	772 726	772 732
4	G 3/4"	85.0	137.0	192.0	93.0	14000	771 925	772 198	772 727	772 733
4	G 1"	85.0	137.0	192.0	93.0	14000	771 926	772 199	772 728	772 734

Ordering chart, Micro lubricator

Oil type CL 32, acc. to DIN 515517 - ISO VG 32

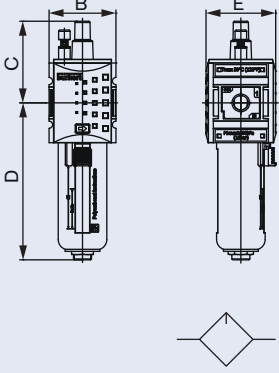

Built size	Port size	B [mm]	C [mm]	D [mm]	E [mm]	Q _{max.} at P=6,3 bar and Δp=1 bar, l/min.	Tank capacity lubricator cm ³	Item no.	
								G-threaded connection	NPT-threaded connection
0	G 1/8"	43.0	58.0	98.0	48.0	1400	35	771 927	n/a
0	G 1/4"	43.0	58.0	98.0	48.0	1400	35	771 928	na
1	G 1/4"	52.0	62.5	123.0	54.0	2800	40	771 929	772 747
1	G 3/8"	52.0	62.5	123.0	54.0	2800	40	771 930	772 748
2	G 3/8"	63.0	69.7	137.5	67.0	8000	80	771 931	772 749
2	G 1/2"	63.0	69.7	137.5	67.0	8000	80	771 932	772 750
4	G 3/4"	85.0	87.9	182.8	93.0	13000	181	771 933	772 751
4	G 1"	85.0	87.9	182.8	93.0	13000	181	771 934	772 752

Ordering chart, Filter 5 µm

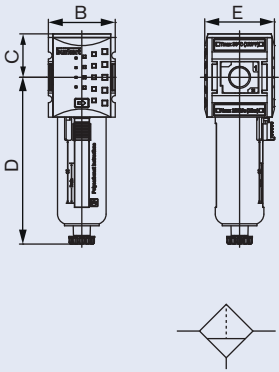

Built size	Port size	B [mm]	C [mm]	D [mm]	E [mm]	Q _{max.} at P=6,3 bar and Δp=1 bar, l/min.	Item no.			
							G-threaded connection with half auto. condensate drain	G-threaded connection with auto. condensate drain	NPT-threaded connection with half auto. condensate drain	NPT-threaded connection with auto. condensate drain
0	G 1/8"	43.0	27.0	105.0	48.0	950	771 935	772 200	n/a	n/a
0	G 1/4"	43.0	27.0	105.0	48.0	950	771 936	772 201	n/a	n/a
1	G 1/4"	52.0	34.0	130.0	54.0	2200	771 937	772 202	772 735	772 767
1	G 3/8"	52.0	34.0	130.0	54.0	2400	771 938	772 203	772 736	772 768
2	G 3/8"	63.0	42.5	147.0	67.0	3500	771 939	772 204	772 737	772 769
2	G 1/2"	63.0	42.5	147.0	67.0	3500	771 940	772 205	772 738	772 770
4	G 3/4"	85.0	58.0	192.0	93.0	8000	771 941	772 206	772 739	772 771
4	G 1"	85.0	58.0	192.0	93.0	8200	771 942	772 207	772 740	772 772

Ordering chart, Fine filter 0,01 µm

with semi-automatic condensate drain

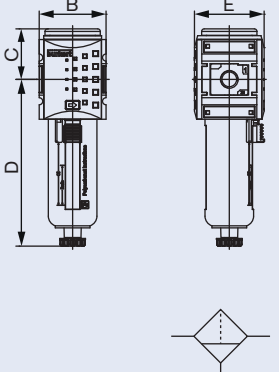

Built size	Port size	B [mm]	C [mm]	D [mm]	E [mm]	Q _{max.} at P=6,3 bar and Δp=1 bar, l/min.	Item no.	
							G-threaded connection	NPT-threaded connection
0	G 1/8"	43.0	27.0	105.0	48.0	350	771 943	n/a
0	G 1/4"	43.0	27.0	105.0	48.0	350	771 944	n/a
1	G 1/4"	52.0	38.0	130.5	54.0	350	771 945	772 785
1	G 3/8"	52.0	38.0	130.5	54.0	350	771 946	772 786
2	G 3/8"	63.0	48.0	147.0	67.0	500	771 947	772 787
2	G 1/2"	63.0	48.0	147.0	67.0	500	771 948	772 788
4	G 3/4"	85.0	63.0	192.0	93.0	1500	771 949	772 789
4	G 1"	85.0	63.0	192.0	93.0	1500	771 950	772 790

Ordering chart, Activated carbon filter

remaining oil content <0,005 mg/m³

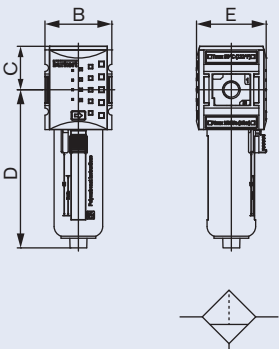

Built size	Port size	B [mm]	C [mm]	D [mm]	E [mm]	Qmax. at P=6,3 bar and Δp=1bar, l/min.	Item no.	
							G-threaded connection	NPT-threaded connection
0	G 1/8"	43.0	27.0	98.0	48.0	600	771 951	n/a
0	G 1/4"	43.0	27.0	98.0	48.0	600	771 952	n/a
1	G 1/4"	52.0	34.0	124.0	54.0	650	771 953	772 791
1	G 3/8"	52.0	34.0	124.0	54.0	650	771 954	772 792
2	G 3/8"	63.0	43.0	141.0	67.0	1300	771 955	772 793
2	G 1/2"	63.0	43.0	141.0	67.0	1300	771 956	772 794
4	G 3/4"	85.0	58.0	184.0	93.0	2000	771 957	772 795
4	G 1"	85.0	58.0	184.0	93.0	2000	771 958	772 796

Ordering chart, Diaphragm pressure regulator

without pressure gauge and mounting parts

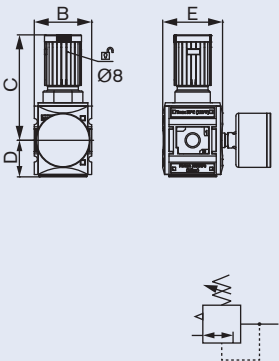

Built size	Port size	B [mm]	C [mm]	D [mm]	E [mm]	Qmax. at P=6,3 bar and Δp=1bar, l/min.	Item no.	
							G-threaded connection	NPT-threaded connection
0	G 1/8"	43.0	63.0	25.0	48.0	1000	771 959	n/a
0	G 1/4"	43.0	63.0	25.0	48.0	1000	771 960	n/a
1	G 1/4"	52.0	95.5	33.0	54.0	2200	771 961	772 705
1	G 3/8"	52.0	95.5	33.0	54.0	2600	771 962	772 706
2	G 3/8"	63.0	110.0	39.5	67.0	4300	771 963	772 707
2	G 1/2"	63.0	110.0	39.5	67.0	5100	771 964	772 708
4	G 3/4"	85.0	137.0	54.0	93.0	14000	771 965	772 709
4	G 1"	85.0	137.0	54.0	93.0	14000	771 966	772 710

Ordering chart, Diaphragm pressure regulator with continuous pressure supply

without pressure gauge and mounting parts

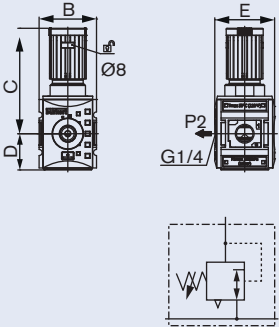

Built size	Port size	B [mm]	C [mm]	D [mm]	E [mm]	Qmax. at P=6,3 bar and Δp=1bar, l/min.	Item no.	
							G-threaded connection	NPT-threaded connection
0	G 1/4"	43.0	68.0	25.0	48.0	1000	771 967	n/a
1	G 1/4"	52.0	95.5	32.5	54.0	2200	771 968	772 711
1	G 3/8"	52.0	95.5	32.5	54.0	2600	771 969	772 712
2	G 3/8"	63.0	110.0	39.5	67.0	4300	771 970	772 713
2	G 1/2"	63.0	110.0	39.5	67.0	5000	771 971	772 714

Ordering chart, Diaphragm precision pressure regulator

without pressure gauge and mounting parts

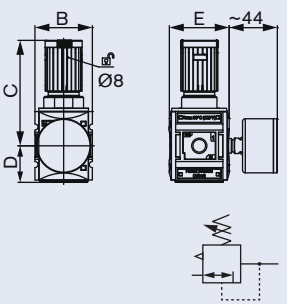

Built size	Port size	B [mm]	C [mm]	D [mm]	E [mm]	Qmax. at P=6,3 bar and Δp=1bar, l/min.	Item no.	
							G-threaded connection	NPT-threaded connection
1	G 1/4"	52.0	95.5	33.0	54.0	2200	771 972	772 715
1	G 3/8"	52.0	95.5	33.0	54.0	2700	771 973	772 716
2	G 3/8"	63.0	110.0	39.5	67.0	4300	771 974	772 717
2	G 1/2"	63.0	110.0	39.5	67.0	5000	771 975	772 718

Ordering chart, Diaphragm precision pressure regulator with continuous pressure supply

without pressure gauge and mounting parts

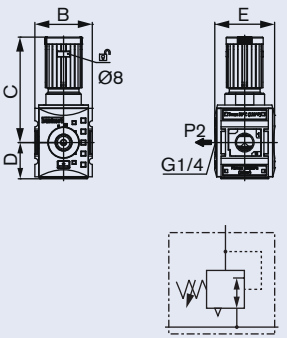

Built size	Port size	B [mm]	C [mm]	D [mm]	E [mm]	Qmax. at P=6,3 bar and Δp=1bar, l/min.	Item no.	
							G-threaded connection	NPT-threaded connection
1	G 1/4"	52.0	95.5	32.5	54.0	2200	771 976	772 719
1	G 3/8"	52.0	95.5	32.5	54.0	2700	771 977	772 720
2	G 3/8"	63.0	110.0	39.5	67.0	4300	771 978	772 721
2	G 1/2"	63.0	110.0	39.5	67.0	5000	771 979	772 722

Ordering chart, 3/2-way control valve

electric operated (not ATEX)

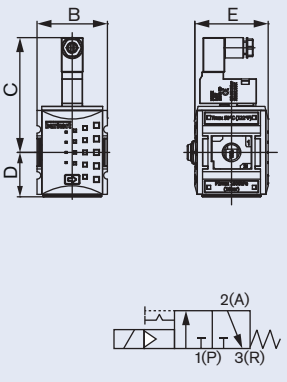

Built size	Port size	B [mm]	C [mm]	D [mm]	E [mm]	Qmax. at P=6,3 bar and Δp=1bar, l/min.	Item no. 24 VDC	Item no. 230 VAC
0	G 1/4"	43.0	93.0	36.6	48.0	2000	771 981	771 989
1	G 1/4"	52.0	84.5	32.8	54.0	2000	771 982	771 990
1	G 3/8"	52.0	84.5	32.8	54.0	2000	771 983	771 991
2	G 3/8"	63.0	93.5	56.5	67.0	4300	771 984	771 992
2	G 1/2"	63.0	93.5	56.5	67.0	4300	771 985	771 993
4	G 3/4"	85.0	110.9	102.3	93.0	12500	771 986	771 994
4	G 1"	85.0	110.9	102.3	93.0	12500	771 987	771 995

Ordering chart, 3/2-way control valve

pneumatic operated

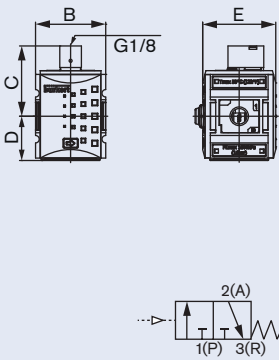

Built size	Port size	B [mm]	C [mm]	D [mm]	E [mm]	Qmax. at P=6,3 bar and Δp=1bar, l/min.	Item no.
0	G 1/8"	43.0	60.1	36.6	48.0	2000	772 000
0	G 1/4"	43.0	60.1	36.6	48.0	2000	772 001
1	G 1/4"	52.0	52.0	33.0	54.0	2000	772 002
1	G 3/8"	52.0	52.0	33.0	54.0	2000	772 003
2	G 3/8"	63.0	60.8	56.5	67.0	4300	772 004
2	G 1/2"	63.0	60.8	56.5	67.0	4300	772 005
4	G 3/4"	85.0	78.2	67.0	93.0	12500	772 006
4	G 1"	85.0	78.2	67.0	93.0	12500	772 007

Ordering chart, Soft start valve

Filling time adjustable

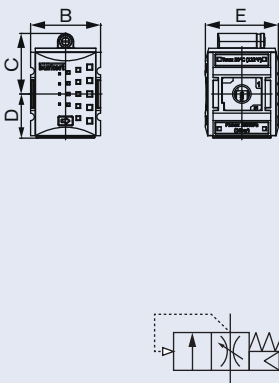

Built size	Port size	B [mm]	C [mm]	D [mm]	E [mm]	Qmax. at P=6,3 bar and Δp=1bar, l/min.	Item no.	
							G-threaded connection	NPT-threaded connection
0	G 1/8"	48.0	53.0	28.0	48.0	1800	772 008	n/a
0	G 1/4"	48.0	53.0	28.0	48.0	1800	772 009	n/a
1	G 1/4"	52.0	45.0	33.0	54.0	1900	772 010	772 773
1	G 3/8"	52.0	45.0	33.0	54.0	1900	772 011	772 774
2	G 3/8"	63.0	53.5	58.0	67.0	4400	772 012	772 775
2	G 1/2"	63.0	53.5	58.0	67.0	4400	772 103	772 776
4	G 3/4"	85.0	58.2	54.0	93.0	10000	772 014	772 777
4	G 1"	85.0	58.2	54.0	93.0	10000	772 015	772 778

Ordering chart, Shut-off ball valve

lockable with padlock

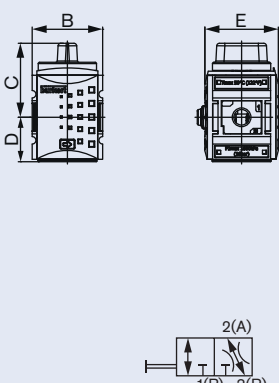

Built size	Port size	B [mm]	C [mm]	D [mm]	E [mm]	Qmax. at P=6,3 bar and Δp=1bar, l/min.	Item no.	
							G-threaded connection	NPT-threaded connection
0	G 1/8"	43.0	51.0	25.0	48.0	1800	772 016	n/a
0	G 1/4"	43.0	51.0	25.0	48.0	1800	772 017	n/a
1	G 1/4"	52.0	54.3	33.0	54.0	1900	772 018	772 568
1	G 3/8"	52.0	54.3	33.0	54.0	1900	772 019	772 742
2	G 3/8"	63.0	70.5	56.5	67.0	5000	772 020	772 743
2	G 1/2"	63.0	70.5	56.5	67.0	5000	772 021	772 569
4	G 3/4"	85.0	93.7	51.0	93.0	14000	772 022	772 745
4	G 1"	85.0	93.7	51.0	93.0	14000	772 023	772 746

Ordering chart, Distributor

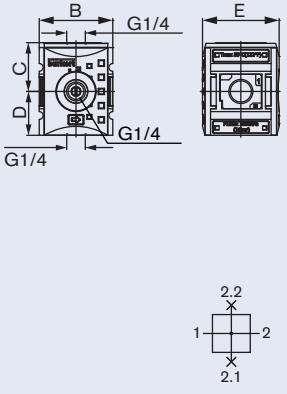

Built size	Port size	B [mm]	C [mm]	D [mm]	E [mm]	Qmax. at P=6,3 bar and Δp=1bar, l/min.	Item no.	
							G-threaded connection	NPT-threaded connection
0	G 1/8"	43.0	28.5	25.0	48.0	2700	772 024	n/a
0	G 1/4"	43.0	28.5	25.0	48.0	2700	772 025	n/a
1	G 1/4"	52.0	34.5	31.0	54.0	2700	772 026	772 779
1	G 3/8"	52.0	54.3	31.0	54.0	3600	772 027	772 780
2	G 3/8"	63.0	70.5	37.5	67.0	7250	772 028	772 781
2	G 1/2"	63.0	70.5	37.5	67.0	7250	772 029	772 782
4	G 3/4"	85.0	93.7	51.0	93.0	18000	772 030	772 783
4	G 1"	85.0	93.7	51.0	93.0	18000	772 031	772 784

Ordering chart, Non return valve

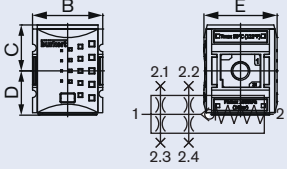

Built size	Port size	B [mm]	C [mm]	D [mm]	E [mm]	Qmax. at P=6,3 bar and Δp=1bar, l/min.	Item no.
0	G 1/8"	43.0	27.0	39.0	48.0	800	772 032
0	G 1/4"	43.0	27.0	39.0	48.0	800	772 033
1	G 1/4"	52.0	34.0	33.0	54.0	1250	772 034
1	G 3/8"	52.0	34.0	33.0	54.0	1250	772 035
2	G 3/8"	63.0	43.0	37.5	67.0	4500	772 036
2	G 1/2"	63.0	43.0	37.5	67.0	4500	772 037

Ordering chart, Bowl (Polycarbonate)

Built size	Port size	Item no. Oil Bowl	Item no. with automatic drain	Item no. with semi-automatic drain
0	G 1/8"	772 046	771 778	772 042
0	G 1/4"	772 046	771 778	772 042
1	G 1/4"	772 047	771 779	772 043
1	G 3/8"	772 047	771 779	772 043
2	G 3/8"	772 048	772 040	772 044
2	G 1/2"	772 048	772 040	772 044
4	G 3/4"	772 049	772 041	772 045
4	G 1"	772 049	772 041	772 045

Ordering chart, Metal bowl

Built size	Port size	Item no. Oil bowl	Item no. with automatic drain	Item no. with semi-automatic drain
0	G 1/8"	772 058	772 050	772 054
0	G 1/4"	772 058	772 050	772 054
1	G 1/4"	772 059	772 051	772 055
1	G 3/8"	772 059	772 051	772 055
2	G 3/8"	772 060	772 052	772 056
2	G 1/2"	772 060	772 052	772 056
4	G 3/4"	772 061	772 053	772 057
4	G 1"	772 061	772 053	772 057

Mounting bracket for control panel mounting, steel galvanized

Size 0
Item no. 772 062

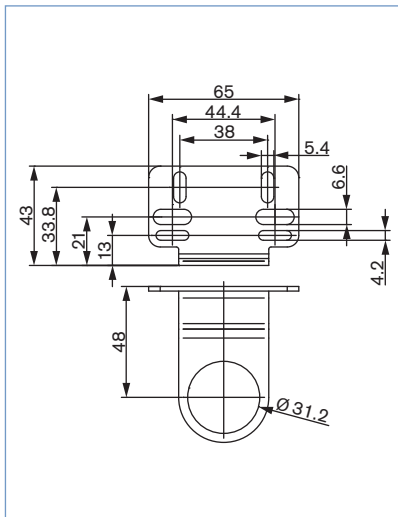

Size 1
Item no. 772 063

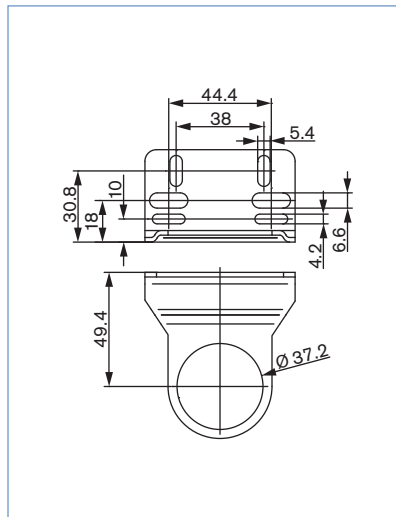

Size 2
Item no. 772 064

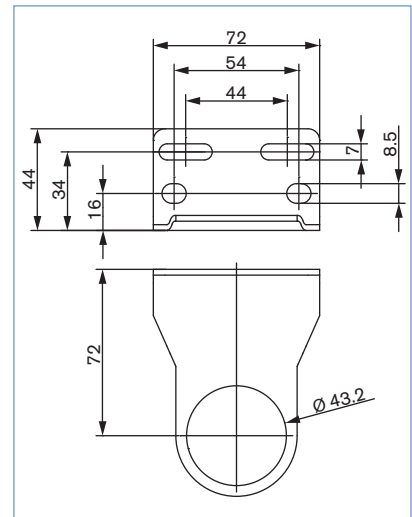

Ordering chart, Control panel nut

Built size	Thread	Materials	Item no.
0	M30x1,5	POM	772 065
1	M36x1,5	POM+GF	772 066
2	M42x1,5	POM+GF	772 067

Mounting bracket for wall-mounting with 2x screw 3x10 with Torx 10IP, steel galvanized

Size 0, Item no. 772 068

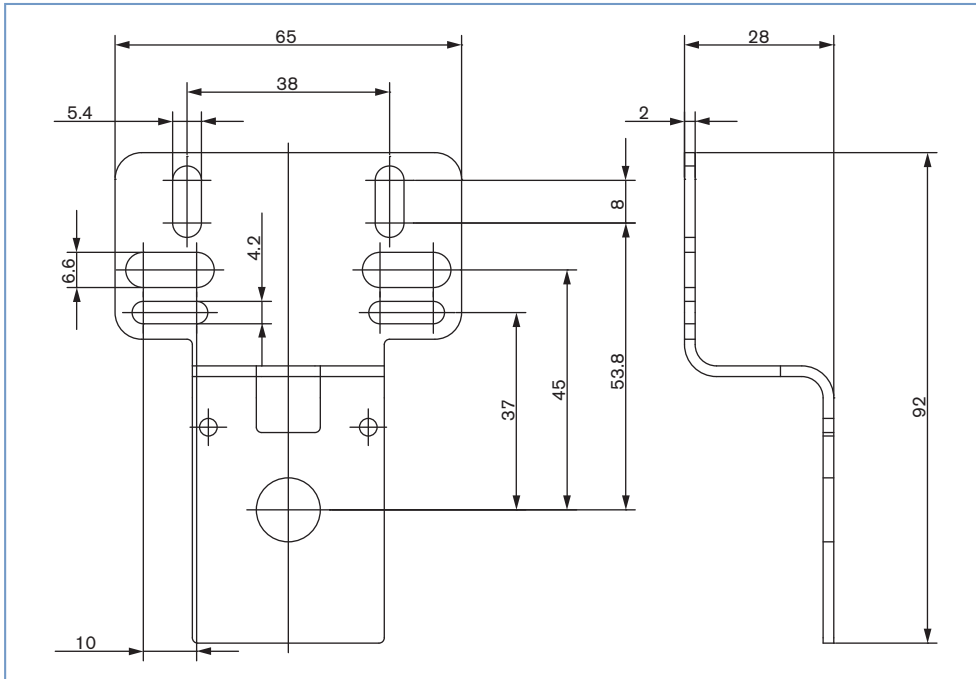

Size 1, Item no. 772 069

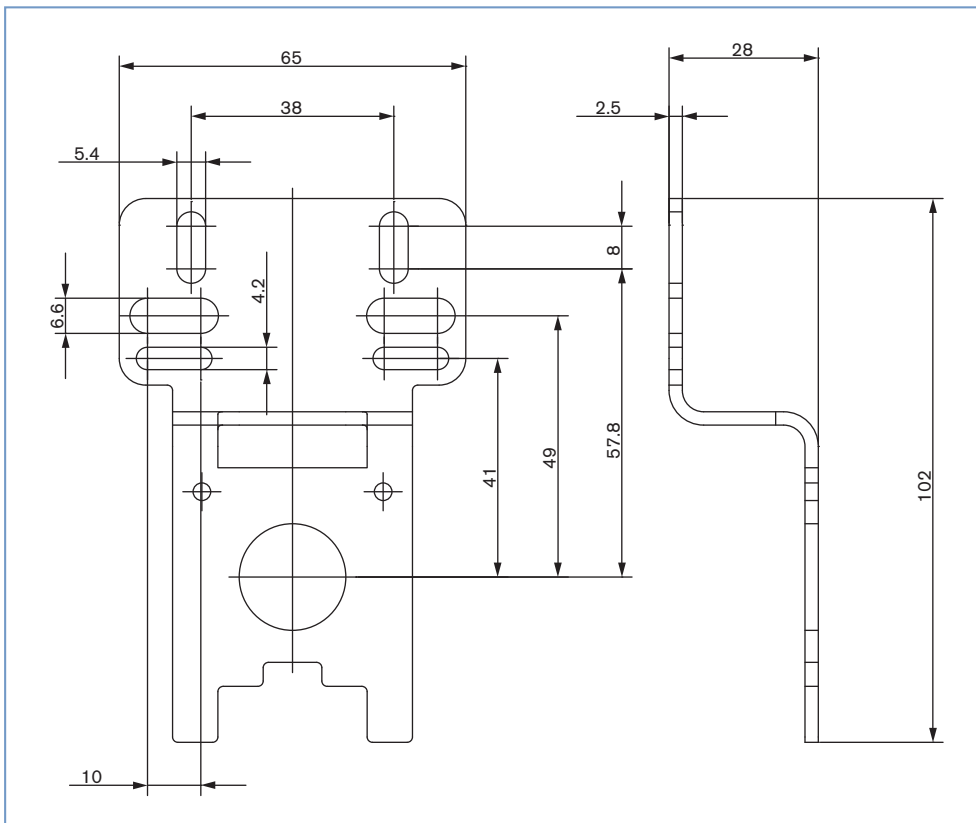

Mounting bracket for wall-mounting with 2x screw 3x10 with Torx 10IP, steel galvanized

Size 2, Item no. 772 070

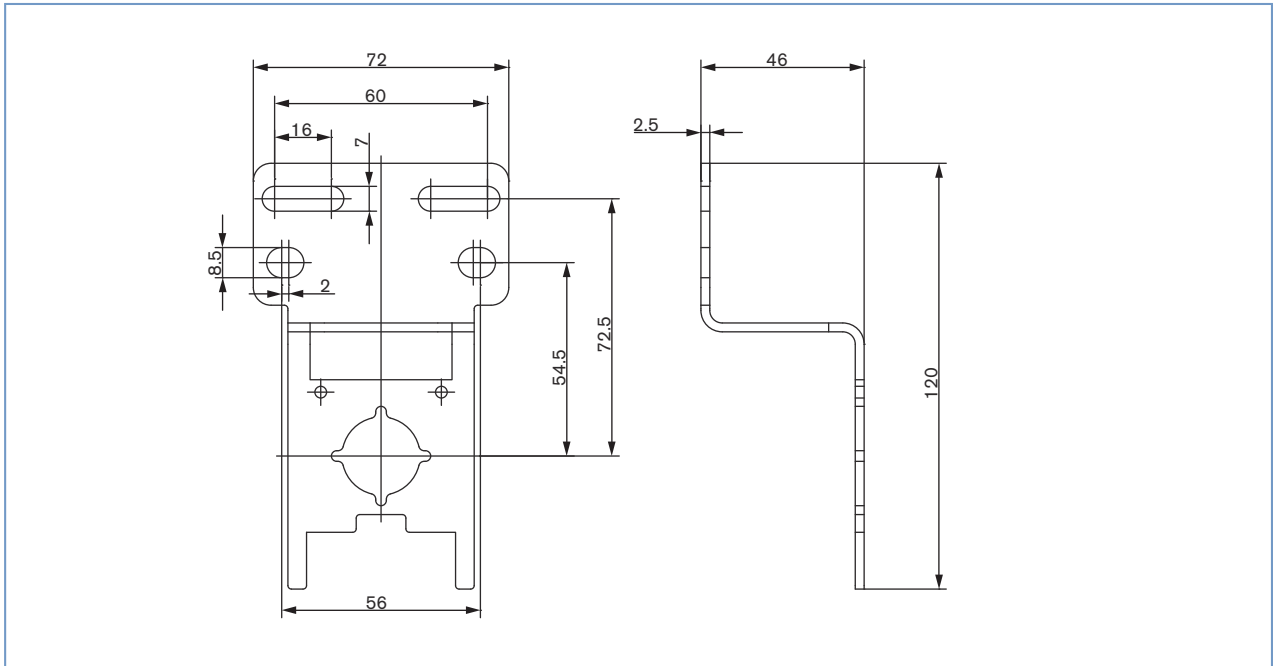

Size 4, Item no. 772 071

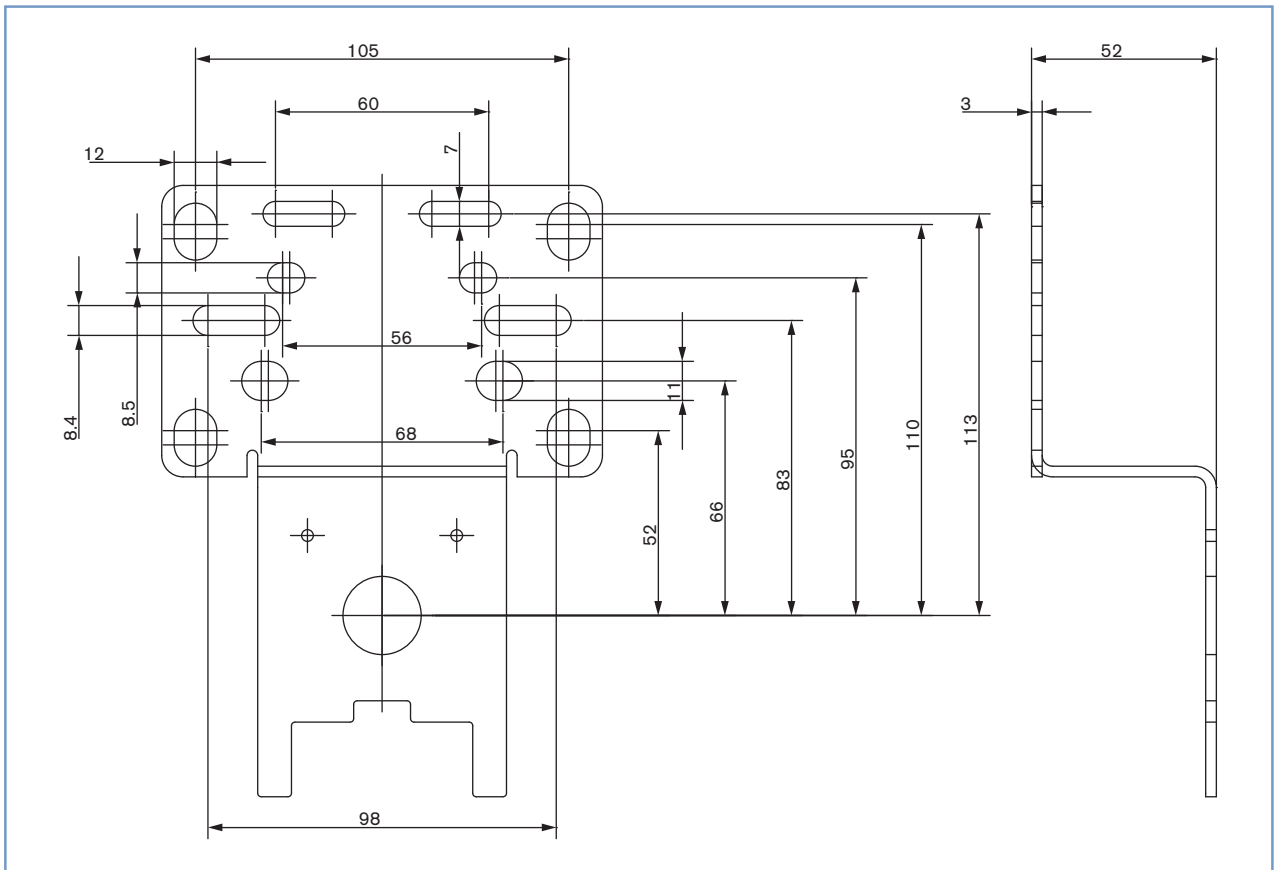

Ordering chart, coupling kit
for connecting of components

	Built size	Item no.
	0	772 072
	1	772 073
	2	772 074
	4	772 075

Ordering chart, coupling kit for wall mounting
for connecting of components, including mounting option for wall mounting

	Built size	Item no.
	0	772 076
	1	772 077
	2	772 078
	4	772 079

Ordering chart, replacement filters

Built size	Item no. Filter 5µm	Item no. Filter 0,01µm	Item no. Activated carbon filter
0	772 080	772 085	772 089
1	772 080	772 084	772 088
2	772 082	772 086	772 090
4	772 083	772 087	772 091

Ordering chart Accessories

Bourdon tube pressure gauge, 0–12 bar, 160 psi, TAU001

	Version	Built size	Item no.
	Ø 40 mm, G 1/8"	0	772 137
	Ø 50 mm, G 1/4"	1.2	772 138
	Ø 50 mm, 1/4" NPT	1.2	772 805
	Ø 63 mm, G 1/4"	4	772 139

To find your nearest Burkert facility, click on the orange box



www.burkert.com

In case of special application conditions,
please consult for advice.

Subject to alterations
© Christian Bürkert GmbH & Co. KG

1504/4_EU-en_00895231